

Installation

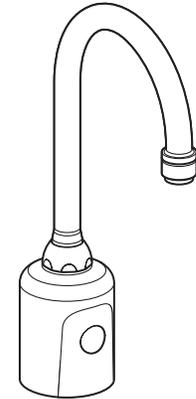

Aerada 1000

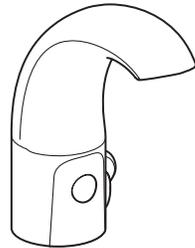

Aerada 1100

Aerada 1000 Series Faucet
S53-326 AC Gooseneck
S53-327 DC Gooseneck



Aerada 1100 Series Faucet
S53-328 AC High Arc Infrared
S53-329 DC High Arc Infrared



Table of Contents

Supplies Required	2
Installation	4
Manual Settings	6
Adjustments	9
Troubleshooting	10
Care and Maintenance	12
Multi-Faucet Transformer Wiring	14

IMPORTANT

Read this entire installation manual to ensure proper installation. When finished with the installation, file this manual with the owner or maintenance department. Compliance and conformity to local codes and ordinances is the responsibility of the installer.

Pressurized plumbing fixtures shall be installed in accordance with manufacturer's recommendations. The supply piping to these devices shall be securely anchored to the building structure to prevent installed device from unnecessary movement when operated by the user. Care shall be exercised when installing the device to prevent marring the exposed significant surface.

Separate parts from packaging and make sure all parts are accounted for before discarding packaging material. If any parts are missing, do not begin installation until you obtain the missing parts.

Make sure that all water supply lines have been flushed and then completely turned off before beginning installation. Do not use pipe dope. Debris in supply lines can cause valves to malfunction.

Do not modify or convert this Faucet; any modifications will void warranties.

Product warranties may be found under "Products" on our web site at www.bradleycorp.com.



Faucet Accessories

Part No.	Description
150-221	4" Cover Plate
232-008	Plugin Transformer
232-009	Hardwired Transformer (1-8 faucets)
269-2479	.5 GPM Non-Aerating Flow for Gooseneck
269-2478	.5 GPM Non-Aerating Flow for High Arc
269-1923	2.2 GPM Laminar Flow for Goodneck*
269-1922	2.2 GPM Laminar Flow for High Arc*
261-010	6V Lithium Battery CR-P2

*2.2 GPM flow control does not meet California Energy Commission 20 CCR T.20, Div. 2, 1601-1609.

COMPONENT PARTS

Aerada 1100 Series

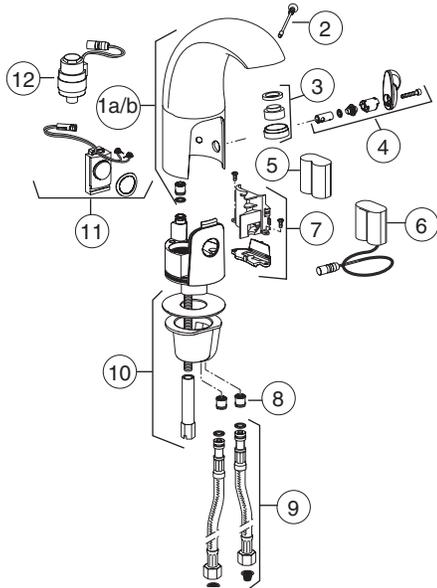

Aerada 1000 Series

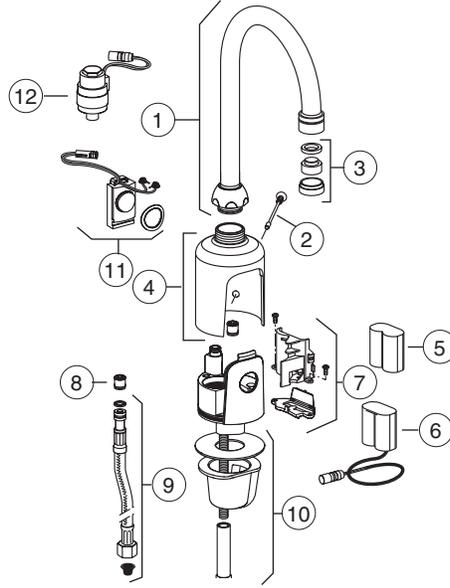

High Arc Components

Part No.	Description
269-1960	Spout with External Mixer Opening
269-1944	Shutoff Screw Assembly
269-1946	Outlet Assembly Kit Lavatory Spout (.5 GPM)
269-1945	Mixer Kit
261-010	6V Lithium Battery CR-P2
269-1942	AC Adapter Kit
269-1961	Battery Holder Kit
198-013	Check Valve
269-1943	Braided Hose with Inlet Filter
269-1948	Filter Only
269-1949	Deck Mounting Hardware Kit
269-1941	Electronics Module Kit
269-1940	Solenoid Repair Set

Gooseneck Components

Part No.	Description
269-1958	Spout
269-1944	Shut Off Screw Assembly
269-1947	Outlet Assembly Kit Spout (.5 GPM)
269-1959	Gooseneck Base without Opening
261-010	6 V Lithium Battery CR-P2
269-1942	AC Adapter Kit
269-1961	Battery Holder Kit
198-013	Check Valve
269-1943	Braided Hose with Inlet Filter
269-1948	Filter Only
269-1949	Deck Mounting Hardware Kit
269-1941	Electronics Module Kit
269-1940	Solenoid Repair Kit

Installation

This faucet comes with all the components needed for installation, however, some tools and supplies are not included.

- Basin Wrench
- Adjustable Wrench
- Adjustable Locking Pliers
- Plumber's Putty
- Hex Key (supplied)
- Outlet Key (supplied)



Do not use pipe dope on faucet and supply connections. Possible solenoid contamination could occur and will void any warranty.

Mounting of Lavatory and Gooseneck Faucet

Before mounting faucet, be sure:

- Supply Valve is installed
- Water supply lines are flushed properly
- For AC faucets, power outlet is installed



It is not necessary to unscrew the connection between braided hose and housing to install the product



Do not remove protective covering from sensor until starting up faucet operation.



Do not tighten locknut before step 4 is completed.

1

Mount cover plate, if required. Plumber's putty is recommended to seal the cover plate to the sink. Security pin must be located on the left side.

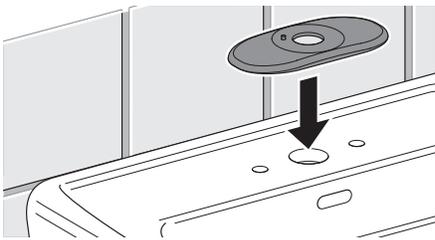

2

Mount gasket and put faucet into sink.

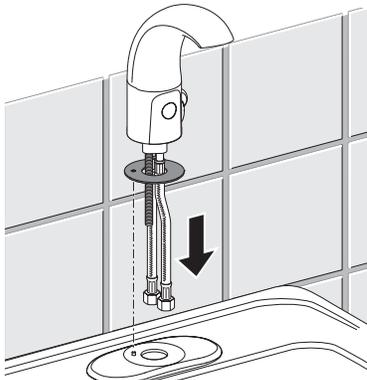

3

Mount bracket from underneath. Place hoses through large opening and mounting rod through small opening. Make sure flange sits securely against surface.

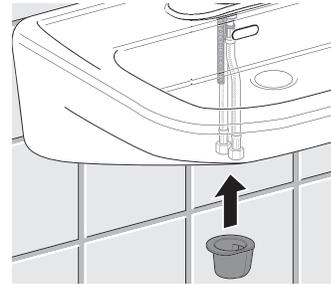

4

Place nut onto mounting rod and tighten with wrench.

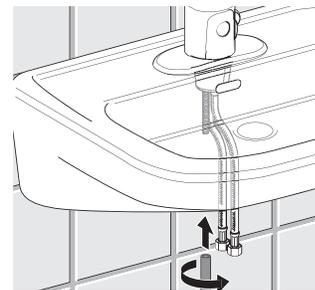

5

If faucet was installed with cover plate, secure with basin washer, flat washer and locknut.

6

Install aerator and tighten with aerator key (supplied).



7

For Gooseneck faucets, tighten spout with wrench.

8

Connect braided hose with filter to supply valve. Cold water > white label Hot water > no label

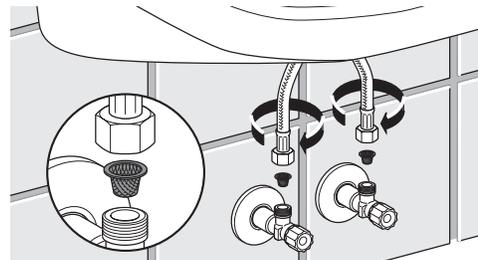

For AC faucets, please refer to the plugin or hardwired transformer installation instructions.

9

Connect to power supply.

Start-Up Operation

Before startup operation, be sure:

- Faucet is mounted
- Water supply is on
- Water supply lines are flushed properly
- For AC faucets, power outlet is installed.

1 Fully open supply valves.

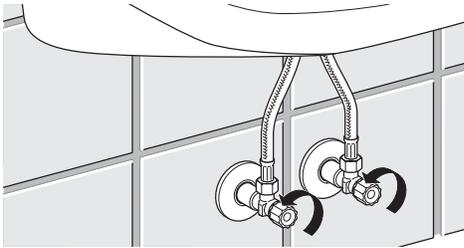

2 Remove all items from sink.

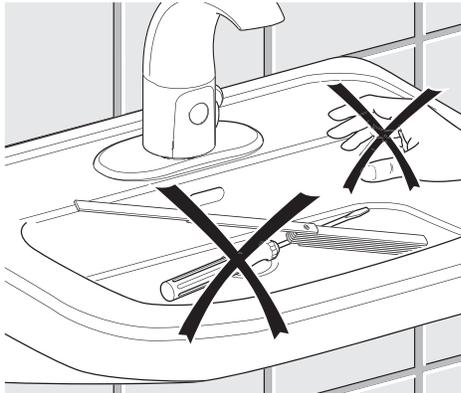

3 Remove protective covering from sensor.

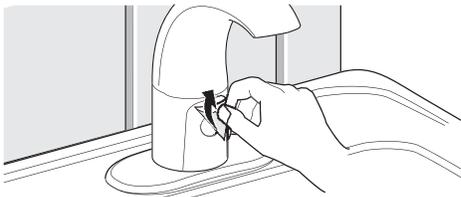

4 Wait for 15 seconds for the faucet to calibrate to its environment. After 15 seconds, the faucet is now activated.

15 sec.



Test Function

1 Hold hand in front of sensor. Water should start to flow.

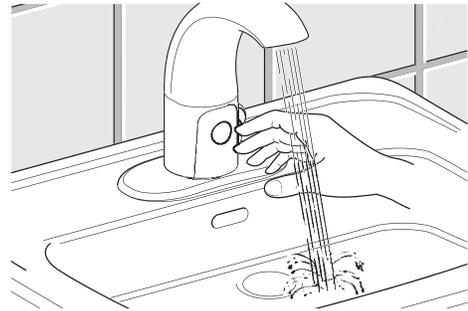

⚠ CAUTION Hot water may burn skin. Hold hand carefully under water and remove quickly.

2 For faucets with external mixer, turn mixer handle from cold to warm. Water temperature should increase.

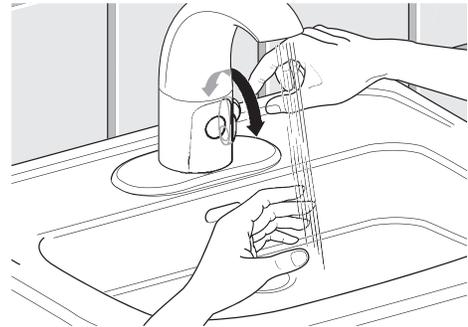

3 Remove hand. Water should stop flowing.



Enabling "Manual Setting Mode"

A battery model is shown in the following example. These instructions apply to all models. After 30 minutes, the "Manual Setting" mode will be disabled automatically and all settings will be saved.

Before enabling mode, be sure:

- Water supply valve is open.
- Battery is full (LED does not blink) for DC faucets.
- AC power is on for AC faucets.

1 Remove shut-off screw.



2 Remove mixer handle (only for faucets with external mixer).

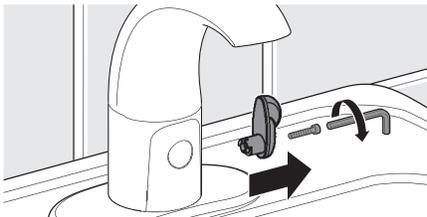

3 Remove housing vertically.

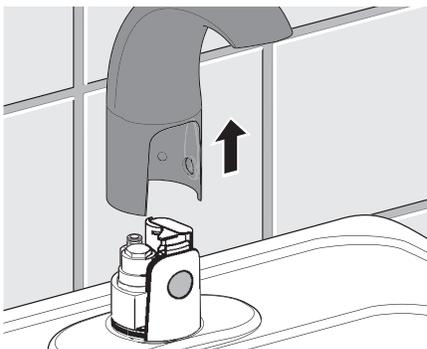

4 Remove battery from battery holder.

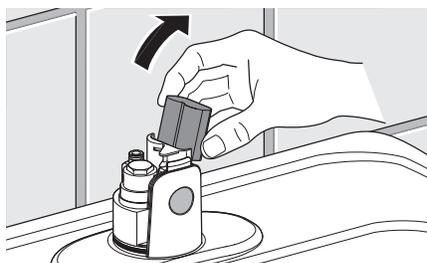

5

The following procedure (a, b, c) must be done three (3) times in a row.

- a - Re-insert battery
- b - LED lights up
- c - Remove battery immediately after LED switches off.

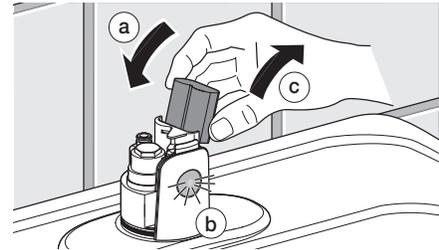

6

Insert battery.

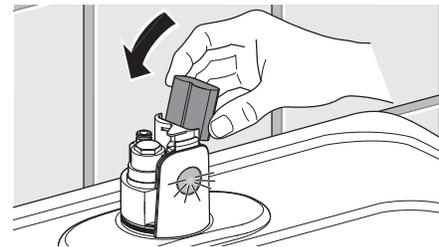

7

Mount housing vertically.

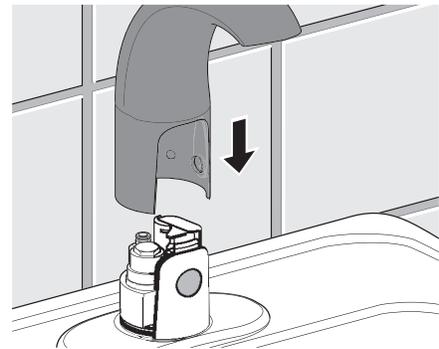

8

Mount shut-off screw.



- 9** Mount mixer handle (only for faucets with external mixer).

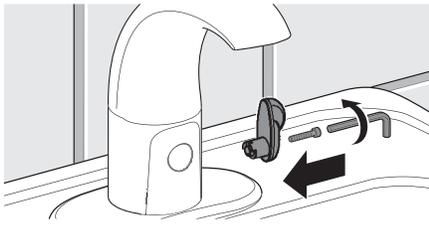

Setting Faucet Mode

Setting the cleaning mode will make the faucet inactive for 90 seconds.

- 1** Enable "Manual Setting" Mode (see "Manual Setting Mode" on page 5).
- 2** Fully cover sensor with hand until water flow stops. This takes 5 seconds.

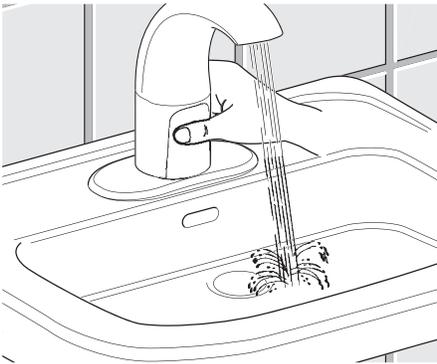

- 3** Remove hand. The Cleaning Mode is now active. For the next 90 seconds, the faucet will be inactive.

Setting Normal Mode

Setting the normal mode will allow the faucet to activate only when it senses a hand presence.

- 1** Enable "Manual Setting" Mode (see "Manual Setting Mode" on page 5).
- 2** Fully cover sensor with hand. Water flow stops after 5 seconds. Continue to hold on for one (1) additional water pulse.



- 3** Remove hand. Normal Mode is now activated.

Setting Metering Mode (10 seconds)

Setting the metering mode will allow the faucet to activate for a full 10 seconds after it senses a hand presence.

- 1** Enable "Manual Setting" Mode (see "Manual Setting Mode" on page 5).
- 2** Fully cover sensor with hand. Water flow stops after 5 seconds. Continue to hold on for another two (2) additional water pulses.



- 3** Remove hand. Metering Mode is now activated for 10 seconds.

Setting Scrub Mode (60 seconds)

Setting scrub mode for 60 seconds will allow the faucet to activate for 60 seconds from the last hand presence.

- 1** Enable "Manual Setting" Mode (see "Manual Setting Mode" on page 5).
- 2** Fully cover sensor with hand. Water flow stops after 5 seconds. Continue to hold on for another three (3) additional water pulses.

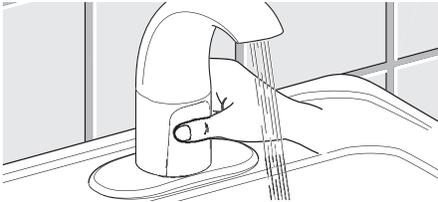

- 3** Remove hand. Scrub Mode is now activated for 60 seconds.

Setting Scrub Mode (180 seconds)

Setting scrub mode for 180 seconds will allow the faucet to activate for 180 seconds from the last hand presence.

- 1** Enable "Manual Setting" Mode (see "Manual Setting Mode" on page 5).
- 2** Fully cover sensor with hand. Water flow stops after 5 seconds. Continue to hold on for another four (4) additional water pulses.

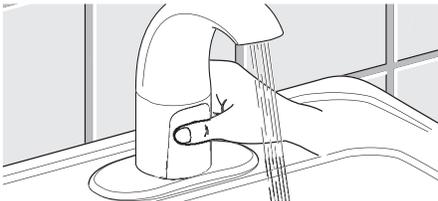

- 3** Remove hand. Scrub Mode is now activated for 180 seconds.

Sensor Range Adjustment

The detection distance of the sensor can be adjusted between approximately 4 - 11 inches from the infrared window.

- 1** Enable "Manual Setting" Mode (see "Manual Setting Mode" on page 5).
- 2** Remove all items from the sink.

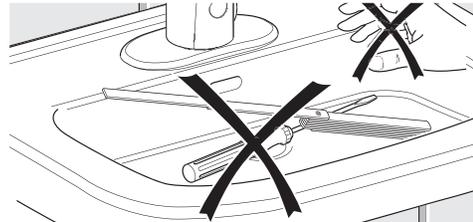

- 3** Fully cover sensor with hand. Water flow stops after 5 seconds. Continue to hold on for five (5) additional water pulses.



- 4** Remove hand.
- 5** Hold hand in the current detection area until LED flashes. Then move hand to the desired detection distance. When LED stays lit for two (2) seconds, detection distance has been re-set to new location.



Reset

All settings will be reset to default settings. The "Manual Setting" Mode will be disabled.

To reset all settings to default, follow steps in "Enabling Manual Setting Mode" but Step 5 needs to be done six (6) times in a row.

Faucet Adjustments

Operating modes and sensor ranges can be adjusted with a manual operation through the infrared sensor. Faucet adjustment operations apply to all models.

Operating Modes

Operating Modes	Description
Cleaning Mode	The faucet is inactive for 90 seconds.
Normal Mode	The faucet is activated if it senses a hand presence. This is the default operating mode of the faucet.
Metering Mode (10 s)	The faucet will shut off after 10 seconds regardless of hand presence detected.
Scrub Mode (60 s)	The faucet will shut off 60 seconds after the detection of the last hand presence.
Scrub Mode (180 s)	The faucet will shut off 180 seconds after the detection of the last hand presence.
Sensor Range Adjustment	Change the detection distance of the infrared sensor. The default sensor range is approximately 1" beyond the spout.
Reset	All settings will be reset to original factory settings.

In order to set the operating modes, the faucet needs to be placed into "Manual Setting" mode. At this time, operating modes can be changed within the next 30 minutes.

The following is a functional diagram to show the different settings available for manual faucet adjustment. See detailed instructions on pages 5 through 7.

Function Diagram of Operating Modes

Modes	Water Pulses in Second(s)										
	5	4	1	4	1	4	1	4	1	4	1
Cleaning Mode											
Normal Mode											
Metering Mode (10 seconds)											
Scrub Mode (60 seconds)											
Scrub Mode (180 seconds)											
Sensor Range Adjustment											

Water is Off
 Water is On

Troubleshooting

Problem	Possible Cause	Solution
No water flow	Supply valves are closed	Open supply valves
	Aerator is blocked or dirty	Clean or replace aerator (See "Care and Maintenance")
	Inlet water line filter is dirty or blocked	Clean or replace filter (See "Care and Maintenance")
	Braided hose is kinked	Eliminate braided hose kink
	No external water pressure	Check water pressure/Provide water pressure
	Battery is drained (DC faucets only)	Replace battery (See "Care and Maintenance")
	Battery contacts are corroded (DC faucets only)	Clean contacts or replace battery (See "Care and Maintenance")
	Reverse battery insertion	Insert battery correctly
	Connector between transformer and power adapter unplugged (AC faucets only)	Plug connector
	Power adapter contacts are corroded (AC faucets only)	Clean contacts
	Connecting cable is kinked or broken (AC faucets only)	Replace defective parts (See "Replacement Parts")
	No external power supply (AC faucets only)	Check external power supply/Provide power supply
	Shut-off screw is missing or defective	Replace shut-off screw (See "Replacement Parts")
	Solenoid valve inoperable	Replace solenoid valve (See "Replacement Parts")
	Faucet is in cleaning mode	Wait for cleaning mode to end (appr. 90 seconds)
	Electronics module inoperable	Contact Bradley technical service or replace power adapter (See "Replacement Parts")
	Power adapter defective (AC faucets only)	Contact Bradley technical service or replace power adapter (See "Replacement Parts")
	Sensor distance is not adjusted properly	Reset sensor monitoring range Remove and re-install shut-off screw. Do not disturb sensor scanning procedure (wait until water flow stops and LED switches off)
Infrared window scratched or dirty	Clean window with smooth cloth	

Problem	Possible Cause	Solution
Water runs continuously and stops when object present	Connector between electronics module and solenoid valve plug is reversed	Plug connector properly
Water runs continuously	Interfering object is in monitoring range	Remove object from monitoring area Remove and re-install shut-off screw. Do not disturb sensor scanning procedure (wait until water flow stops and LED switches off)
	Defective electronics module	Replace electronics module (See "Replacement Parts")
	Improper sensor mode	Change mode or reset sensor (See "Care and Maintenance")
	External water pressure too high	Check external water pressure Provide pressure between 20 - 125 psi
	Solenoid valve inoperable	Replace solenoid valve (See "Replacement Parts")
Water flows although shut-off screw is removed	Electronics module is inoperable	Replace electronics module (See "Replacement Parts")
	Water drops on infrared window	Clean window with smooth cloth
Faucet turns on by itself	Infrared window is dirty or scratched	Clean window with smooth cloth
	Input line pressure fluctuates	Install appropriate line pressure regulators
Faucet is leaking water	Connections between housing and braided hoses are loose	Check O-rings Replace O-rings when damaged or missing
	Connection between braided hose and inlet supply are loose	Check rubber washers Replace washers when damaged or missing
	Connection between valve body and solenoid valve is loose	Check O-rings Replace O-rings when damaged. Carefully reinstall solenoid valve and do not overtighten.
	Faucet drips, solenoid valve does not close properly	Clean or replace solenoid valve (See "Replacement Parts")
Temperature cannot be adjusted properly	No, or too little hot or cold water. Supply valves are not fully opened	Fully open supply valves
	Inlet water line filter is dirty or blocked	Clean or replace filter (See "Care and Maintenance")
	Braided hose is kinked	Eliminate braided hose kink
	Backflow preventer in faucet inlet is blocked	Unblock backflow preventer
	Temperature of hot or cold water supply is too low	Check inlet water temperature or inspect boiler
	Hot water temperature not sufficient	Reverse hot water limiter (See "Care and Maintenance")
	Braided hoses are connected improperly (cold to hot and hot to cold)	Correct the connections

Care and Maintenance

The following are described in this section:

- Activating Cleaning Mode
- Replacing Battery
- Cleaning or Replacing Inlet Filter
- Adjusting Water Temperature (Internal Mixer)
- Adjusting Hot Water Limiter (External mixer)
- Cleaning or Replacing Aerator

Activating Cleaning Mode

In order to set the cleaning mode, the faucet needs to have been set once into the "Manual Setting" mode. See "Manual Setting" instructions. When cleaning mode is activated, the faucet will be inoperable for 90 seconds.

- 1** Fully cover sensor with hand until water flow stops. This takes approximately 5 seconds.

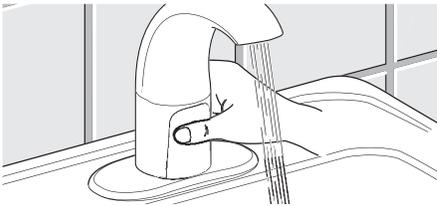

- 2** Remove hand. Cleaning Mode is now activated.

Replacing Battery

A traditional lavatory faucet is shown as an example. These instructions apply to all DC models. Before replacing the batter, be sure that:

- Battery is low (LED is lit)
- New 6 V Lithium battery (CR-P2) is required

- 1** Remove shut-off screw.



- 2** Remove mixer handle (for faucets with external mixer only).

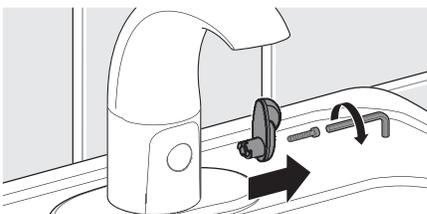

- 3** Remove housing vertically.

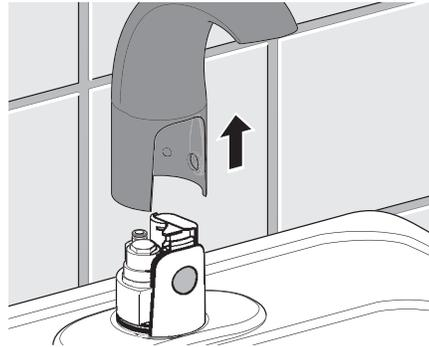

- 4** Remove used battery from battery holder and recycle.

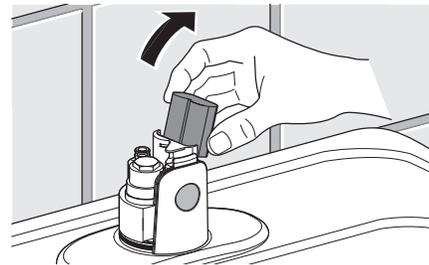

- 5** Insert new battery. The LED lights up for 1 second.

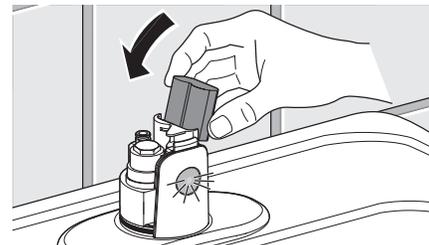

- 6** Mount housing vertically.

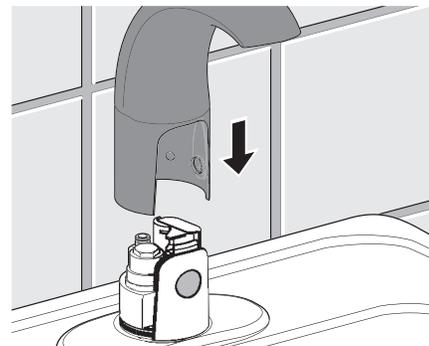

7 Install shut-off screw.



8 Install mixer handle (for faucets with external mixer only).

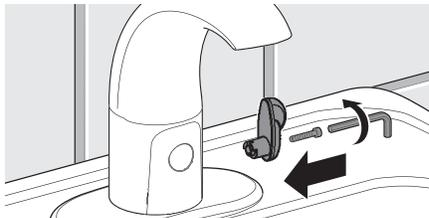

Cleaning or Replacing Inlet Filter

1 Close supply valves.

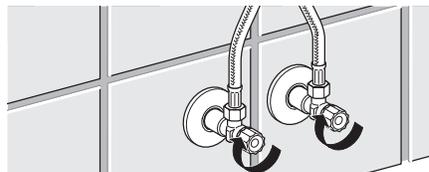

2 Disconnect braided hoses and clean or replace filter. For a new filter, see Replacement Parts section.

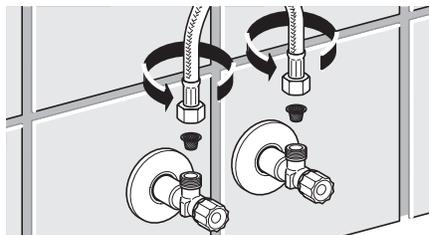

3 Connect braided hose with filter to supply valve. Cold water = White Label Hot Water = No Label

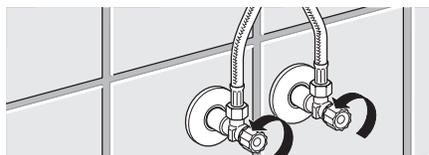

Adjusting Hot Water Limiter (External Mixer)

The proportion of hot water can be switched from approximately 85% to 95% (or reverse) depending upon inlet water pressures and temperatures. The default setting is 85%.

⚠ CAUTION Hot water may burn skin. Hold hand carefully under water and remove quickly.

1 Remove mixer handle.

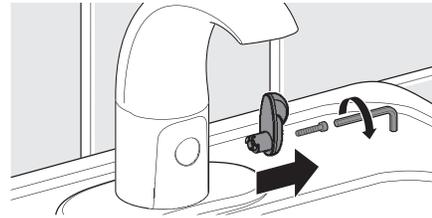

2 Carefully pull out hot water limiter from handle (using pliers) and reverse by 180°.

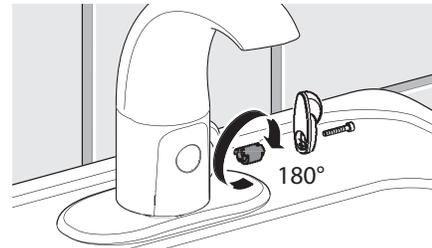

Settings of hot water limiter (view from placement in mixer handle)

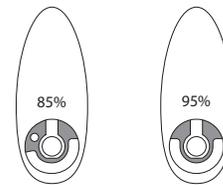

3 Mount mixer handle. The proportion of hot water is now changed.

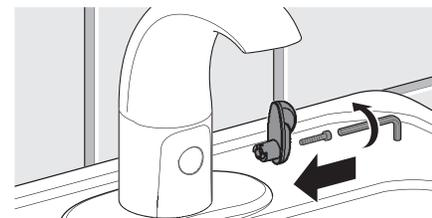

Cleaning or Replacing Aerator

1 Remove shut-off screw.



3 Install shut-off screw.



2 Remove aerator with vandal resistant wrench supplied with the faucet. Clean or replace aerator, then reinstall.

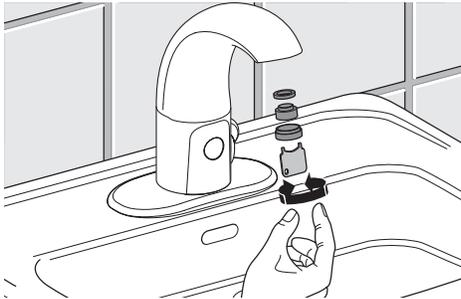

Multi-Faucet Transformer

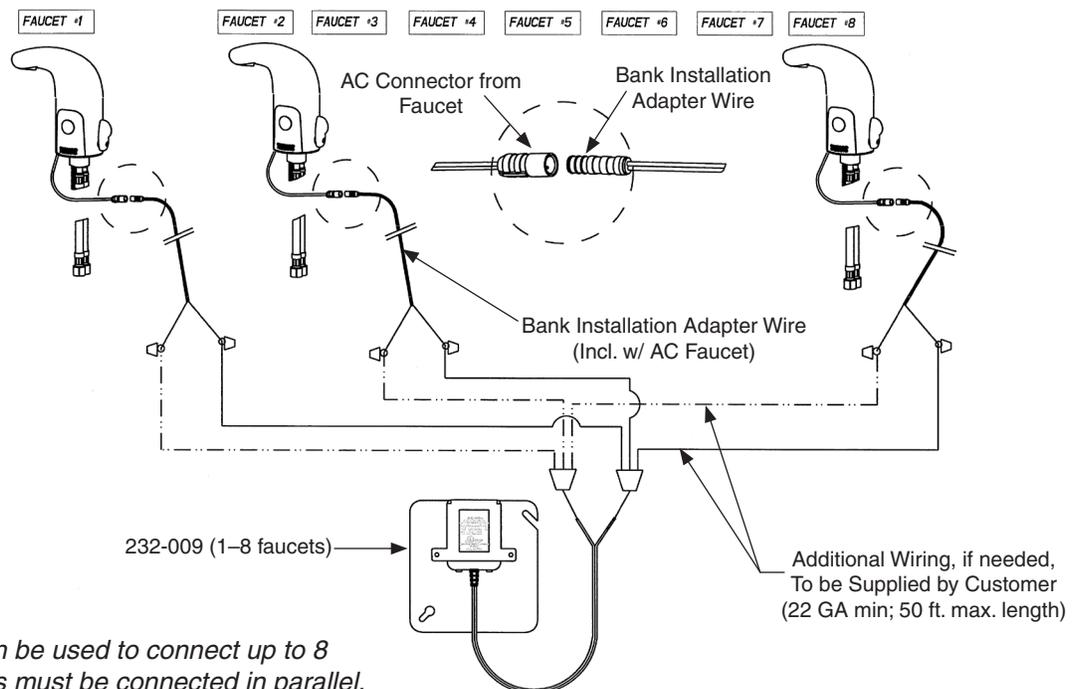

Transformer can be used to connect up to 8 faucets. All units must be connected in parallel.